

USER MANUAL

**METER FOR ELECTRICAL
INSTALLATION PARAMETERS**

MPI-502

MPI-502

Measuring terminals



Start the measurement procedure

Contact electrode

SET/SEL - enter the meter settings, select the digit to change

Shift/selection: right/left, up/down

Turning on and off (after keeping the button depressed for some time) meter power supply, turning on and off the display lighting

ESC - return to the previous screen, exit the function

Approve

FUNCTION CHANGE DIAL

Choice of measuring function:

- **AUTO** - RCD: automatic measurement
- I_A - RCD: response time measurement
- $t_{0,5x}$ - RCD: response time measurement for 0,5I_{in}
- t_{1x} - RCD: response time measurement for 1I_{in}
- t_{2x} - RCD: response time measurement for 2I_{in}
- t_{5x} - RCD: response time measurement for 5I_{in}
- **MEM** - View and erase the memory and data transmission
- R_{CONT} - measurement of resistance of protective and neutral conductors and low-voltage resistance measurement
- **U, f** - measurement of voltage and frequency
- Z_{L-PE} **RCD** - measurement of fault loop impedance in the circuit L-PE protected with a residual current device RCD
- Z_{L-PE} - measurement of fault loop impedance in the circuit L-PE
- Z_{L-N} Z_{L-L} - measurement of fault loop impedance in the circuit L-N or L-L



USER MANUAL

ELECTRICAL INSTALLATION METER MPI-502



**SONEL S.A.
Wokulskiego 11
58-100 Świdnica**

Version 1.22 21.06.2021

The MPI-502 is a modern, state-of-the art measuring instrument, easy to operate and safe. Read this manual to avoid mistakes during the measurements and prevent operational problems.

CONTENTS

1 Safety	5
2 Measurements	6
2.1 Switching on and off, display backlight.....	6
2.2 Selecting general measurement parameters	6
2.3 Remembering the last measurement result	8
2.4 Alternating voltage measurement.....	8
2.5 Voltage and frequency measurement	8
2.6 Verifying the protective conductor connection correctness.....	8
2.7 Measurements of fault loop parameters.....	9
2.7.1 Selecting the lead length.....	9
2.7.2 Prospective short-circuit current.....	10
2.7.3 Measurement of fault loop parameters in the L-N and L-L systems.....	11
2.7.4 Measurement of fault loop parameters in the L-PE system	13
2.7.5 Measurement of fault loop impedance in the L-PE system protected by an RCD.....	15
2.8 Measurement of resistance to earth.....	16
2.9 Measurement of the residual current device parameters.....	17
2.9.1 Measurement of the RCD tripping current	17
2.9.2 Measurement of the RCD tripping time	19
2.9.3 Automatic RCD parameters measurement	21
2.10 Low-voltage resistance measurement	27
2.10.1 Continuity measurements of protective conductors and equipotential bonding (with the ±200mA current)	27
2.10.2 Low-current resistance measurement	28
2.10.3 Test leads resistance compensation – auto-zeroing.....	30
3 Memory of measurement results	31
3.1 Entering the measurement results to te memory	31
3.2 Changing the cell and bank number.....	33
3.3 Browsing the memory.....	33
3.4 Clearing the memory	35
3.4.1 Clearing the bank.....	35
3.4.2 Clearing the whole memory.....	36
3.5 Communication with computer.....	37
3.5.1 Package for cooperation with computer	37
3.5.2 Data transmission with Bluetooth 4.2 module.....	37
3.5.3 Data transmission	38
4 Troubleshooting	39
5 Power supply	41
5.1 Monitoring the power supply voltage	41
5.2 Replacing the batteries.....	41
5.3 General rules of using the Nickel Metal Hydride (Ni-MH) batteries	42
6 Cleaning and maintenance	42
7 Storage	43

8 Dismantling and disposal 43

9 Technical specification 43

9.1 Basic information..... 43

9.2 Additional information..... 48

9.2.1 Additional uncertainty according to IEC 61557-3 (Z)..... 48

9.2.2 Additional uncertainty according to IEC 61557-4 (R ±200mA)..... 48

9.2.3 Additional uncertainty according to IEC 61557-6 (RCD)..... 48

10 Accessories..... 49

10.1 Standard accessories..... 49

10.2 Optional accessories..... 49

11 Manufacturer 50

12 Laboratory services..... 51

1 Safety

The MPI-502 meter is designed for testing the protection against electric shock in the mains systems. The meter is used to make measurements which results determine the electrical installation safety level. Consequently, in order to ensure safe operation and correct measurement results, observe the following recommendations:

- Before you proceed to operate the meter, acquaint yourself thoroughly with the present manual and observe the safety regulations and recommendations of the manufacturer.
- Any application that differs from those specified in the present manual may cause damage of the instrument and a serious hazard to its user.
- The MPI-502 meters must be operated solely by appropriately qualified personnel with relevant certificates to perform measurements of electric installation. Operation of the instrument by unauthorized personnel may result in damage to the device and constitute a hazard to the user.
- Using this manual does not exclude the need to comply with occupational health and safety regulations and with other relevant fire regulations required during the performance of a particular type of work. Before starting the work with the device in special environments, e.g. potentially fire-risk/explosive environment, it is necessary to consult it with the person responsible for health and safety.
- It is unacceptable to operate the following:
 - ⇒ a damaged meter which is completely or partially out of order,
 - ⇒ leads with damaged insulation,
 - ⇒ a meter which has been stored to long in unsuitable conditions (for example is wet). When the meter is transferred from cold environment to warm and humid one, do not make measurements until the meter warms up to the ambient temperature (about 30 minutes).
- Remember that the **batt** message on the display means that the power supply voltage is too low and indicates the need to replace/ charge the batteries. The measurements performed with the meter with insufficient supply voltage have additional measuring errors which are impossible to be evaluated by the user and cannot be the basis to determine the correct protection of the tested installation.
- Do not leave the discharged batteries in the meter as they can leak and damage the instrument.
- Before starting the measurement, check if the leads are connected to correct measuring terminals.
- Never use the meters with open or only partially closed battery compartment cover and use only the power supplies specified in this manual.
- Repairs may be performed solely by an authorized service outlet.

NOTE

Use only standard and optional accessories intended for a given instrument which are listed in the "Equipment" section. Using other accessories may cause damage of the measuring terminal and additional measuring errors.

Note:

Due to continuous development of the meter software, the display view for some functions may be a bit different from the view shown in this manual.

Note:

An attempt to install drivers in 64-bit Windows 8 may result in displaying "Installation failed" message.

Cause: Windows 8 by default blocks drivers without a digital signature.

Solution: Disable the driver signature enforcement in Windows.

2 Measurements



WARNING:

During the measurements (fault loop impedance, RCD) never touch the earthed and accessible parts in the tested electrical installation.

WARNING:

During the measurement do not switch the range selector as this may cause damage of the meter and hazard for the user.

2.1 Switching on and off, display backlight

To switch on the meter, briefly press the  button. To switch off, press the same button longer (the **OFF** message appears). To switch on/off the display and keypad backlight during the meter operation, briefly press the  button.

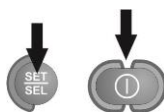

2.2 Selecting general measurement parameters

①



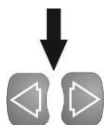

Keeping the **SET/SEL** button depressed, switch on the meter and wait for the parameter selection screen to appear.

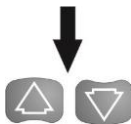

Use the  and  buttons to go to next parameter.



Use the  and  buttons to change the parameter value. The value or symbol to be changed is flashing.

The **YES** symbol indicates an active parameter, the **no** symbol indicates an inactive one.

②

Set the parameters according to the following algorithm:

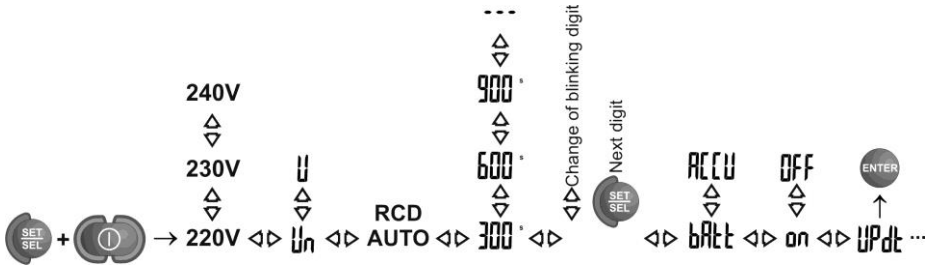

Parameter	Mains voltage	Voltage for calculating I _k : rated/measured	RCD-AUTO parameters	Auto-OFF	Change PIN	Supply source selection	Buzzer	Software updating
Symbol(s)	U _n L-N	I _k	r _{cd} Auto	OFF	P _{in}	SUPP	BEEP	?



Parameter symbol(s)	Z _{L-PE} RCD	x0,5	...	I _A	Auto r _{cd}



Press **ENTER** to save the changes and go to the measurement function.

or



Press **ESC** to go the measurement function without saving the changes.

Notes:

- Before the first measurements, set the mains rated voltage U_n (220/380V, 230/400V or 240/415V) which is applicable in the test location. The voltage is used to calculate the prospective short-circuit current, if this option was chosen from the main menu.
- The symbol means the positive phase or polarization, the symbol – a negative one.
- The --- symbol in the time to auto-off settings, indicates absence of such time.
- The **RCD Auto** mode settings are described in section 2.7.3.
- PIN settings – see section 3.5.2 **Data transmission**.
- To upgrade the software, please proceed do point 3.5.1.

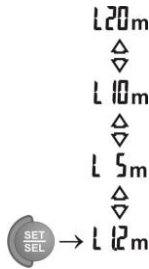

Notes:

Using original leads and selecting correct length is a guarantee of keeping the declared measuring accuracy.

2.7.2 Prospective short-circuit current

The meter always measures the impedance, and the displayed short-circuit current is calculated according to the following formula:

$$I_k = \frac{U_n}{Z_s}$$

where: U_n – rated voltage of the tested mains, Z_s – measured impedance.

Based on the rated voltage U_n selected in the general settings (section 2.1), the meter automatically detects the measurement with phase-to-neutral or phase-to-phase voltage and includes this in the calculations.

If the tested mains voltage is out of tolerance range, the meter will not be able to determine the correct rated voltage for calculation of short-circuit current. In such case, horizontal lines will be displayed instead of the short-circuit current. The figure below shows the voltage ranges for which the short-circuit current is calculated.

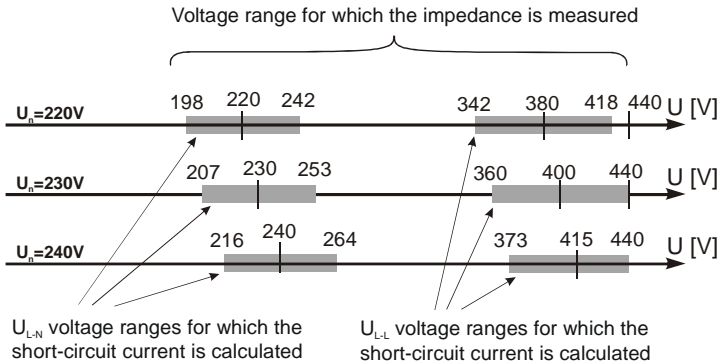

2.7.3 Measurement of fault loop parameters in the L-N and L-L systems

1

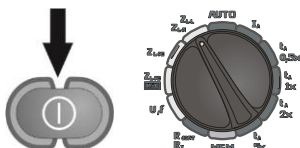

Switch on the meter.
Set the dial switch to the $Z_{L-L} Z_{L-N}$ position.

2

Select the leads length as described in 2.6.1 according to the needs.

3

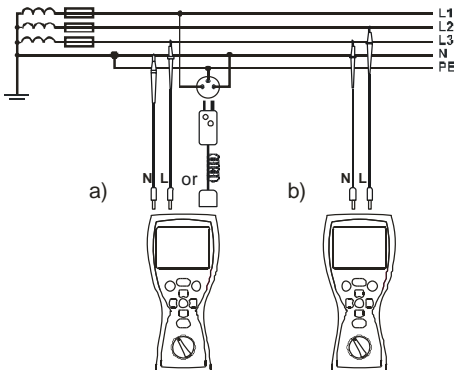

Connect the test leads as shown in the figure
a) for measurement in the L-N circuit or
b) measurement in the L-L circuit

4

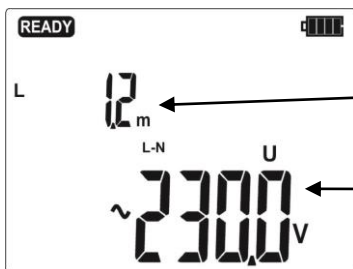

The meter is ready for measurement.

Phase conductor length or the $--E$ symbol.

U_{L-N} or U_{L-L} voltage

5



Press **START** to perform the measurement.

6

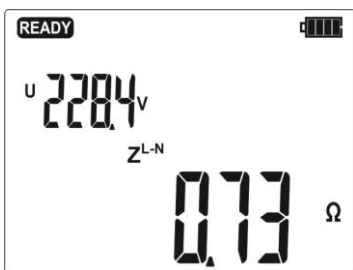

Read the main result:
the fault loop impedance Z_S and the mains voltage during the measurement.

7



Press  to read additional results.

8

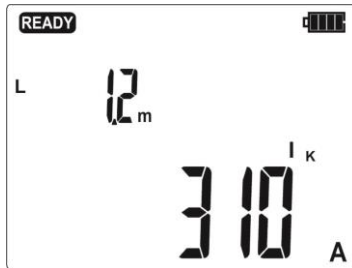

I_K
short-circuit
current.

9

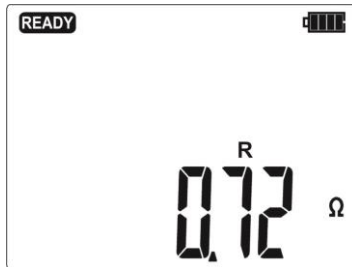

R
fault loop
resistance

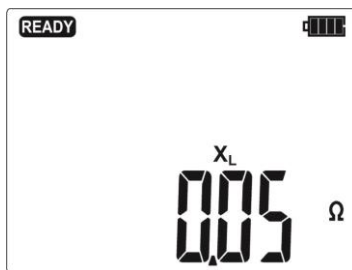

X_L
fault loop
reactance

Note:

- Save the result in the memory (see sections 3.1 and 3.2) or press **ESC** to return to the voltage measurement.
- Making a large number of tests over a short time causes the meter to emit a lot of heat. As a result the casing may become warm. This is normal, and the meter has an overheat protection.
- The minimum time between successive measurements is 5 seconds. This value is controlled by the meter which displays the **READY** message when you can make the next measurement.

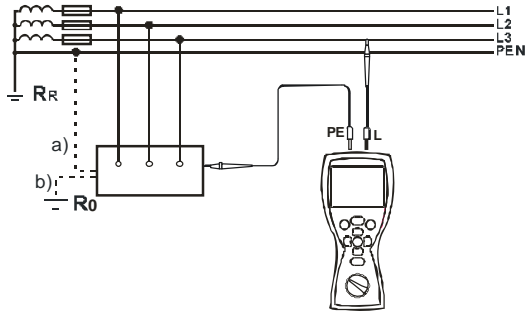

Checking the effectiveness of protection against electric shock of the equipment casing for: a) TN mains b) TT mains.

4

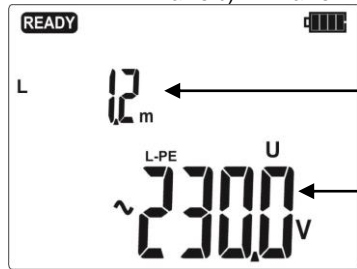

The meter is ready for measurement. Phase conductor length or the $\sim E$ symbol.

U_{L-PE} voltage

5



Press **START** to perform the measurement.

The remaining measurement issues are analogous to the ones described for the measurements in the L-N or L-L systems.

Notes:

- A double-lead measurement is possible when selecting the test lead other than with the socket adapter.

Additional information displayed by the meter

Information and error messages are the same as in case of L-N and L-L.

2.7.5 Measurement of fault loop impedance in the L-PE system protected by an RCD

The MPI-502 allows the fault loop impedance measurements without making changes in the mains with the residual current devices with rated current of minimum 30mA.

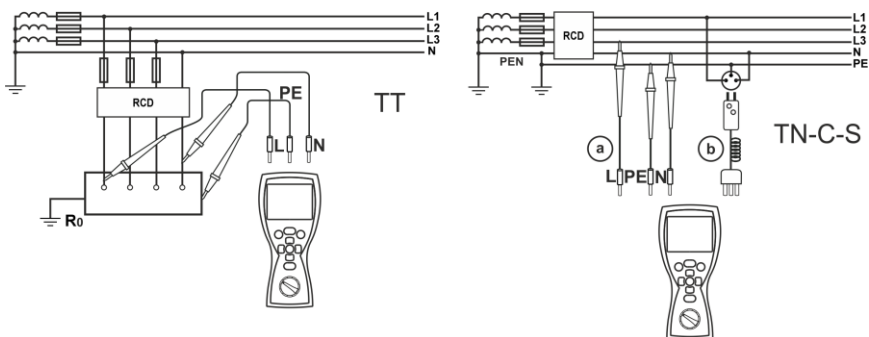
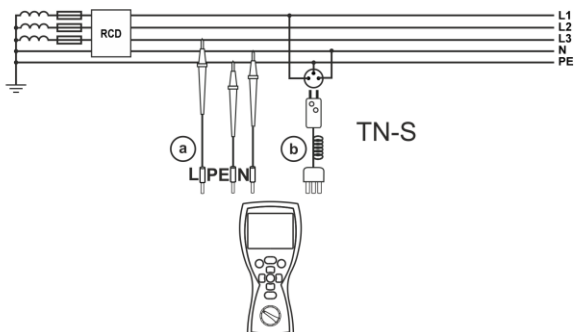
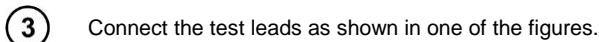
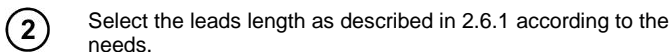
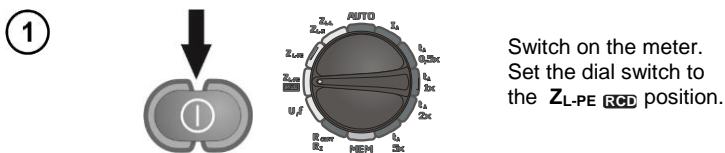

The remaining measurement issues are analogous to the ones described for the measurements in the L-N or L-L systems.

Notes:

- The measurement takes maximum about 32 seconds. You can discontinue the measurement by pressing the **ESC** button.
- In the electrical installations with the 30mA residual current devices the sum of the installation leakage currents and the test current may trip the RCD. In such case, try to reduce the leakage current of the tested installation (i.e. by disconnecting the loads).

Additional information displayed by the meter

Information and error messages are the same as in case of L-N and L-L.

2.8 Measurement of resistance to earth

The MPI-502 instrument can be used for approximate measurements of resistance to earth. For this purpose, the phase conductor is used as secondary source of voltage which generates test current. Connection diagram for the instrument for such measurement in the TN-C, TN-S and TT systems is shown in the figure below, the dial switch must be set to the **Z_{L-PE}** position.

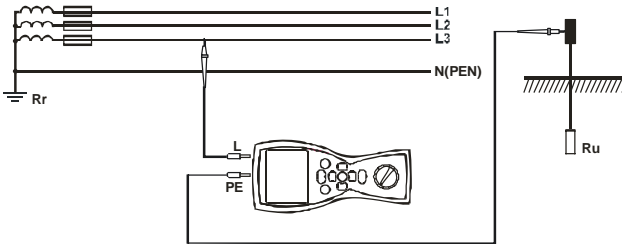

During the measurement check the connections of the measured earth electrode with the electrical installation. For correct measurement, the tested earthing system should be disconnected from the electrical installation (N and PE conductors). If you want to measure the earth electrode, for instance in the TN-C-S system and simultaneously use the phase of the same system as an auxiliary source of current, disconnect the PE and N conductors from the measured earth electrode (see figure below). Otherwise, the meter will measure an incorrect value (the test current will flow not only through the measured earthing system).

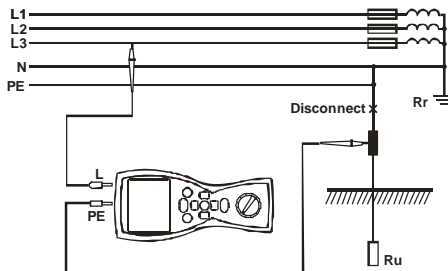

Note:

WARNING:

Disconnection of protective conductors is serious life hazard for the staff performing the measurements and also third parties. When the measurements are completed, the protective and neutral conductors MUST be reconnected.

- If it is not possible to disconnect the conductors, use an earth resistance meter from the MRU range.
- As the measurement result is the sum of impedances of the measured earth electrode, operational earthing system, source and phase conductor, it contains a positive error. However, if such error does not exceed a limit value for the tested earthing system, it can be concluded that the earthing has been made correctly and there is no need for a more accurate measurement methods.

2.9 Measurement of the residual current device parameters

2.9.1 Measurement of the RCD tripping current

1

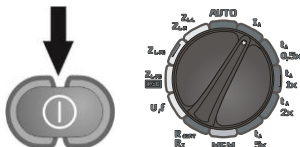

Switch on the meter.
Set the dial switch to the I_A position.

2

Set the parameters according to the following algorithm and the rules for setting the general parameters.

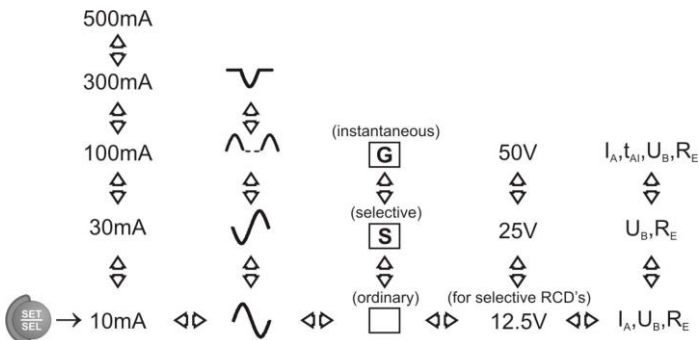

Parameter	I_{An}	Current waveform	RCD type	U_L	Measurement mode
-----------	----------	------------------	----------	-------	------------------

3

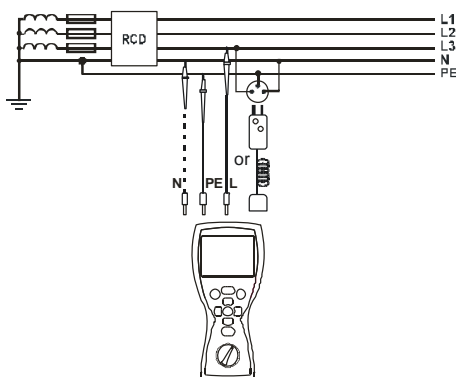

Connect the test leads as shown in the figure.

4

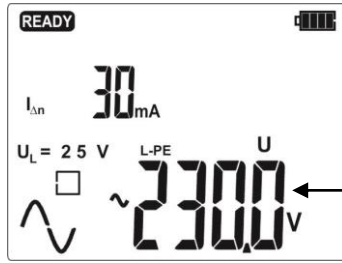

The meter is ready for measurement.

U_{L-PE} voltage

5



Press **START** to perform the measurement.

6

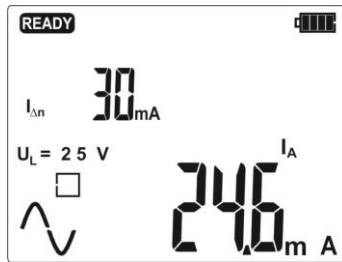

Read the main measurement result: I_A current.

7



Press  to read additional results.

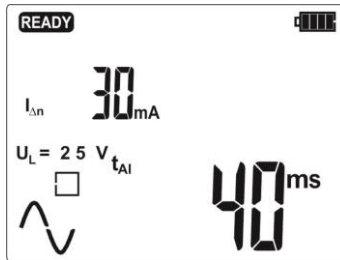

Tripping time t_{AI} at the I_A current

8

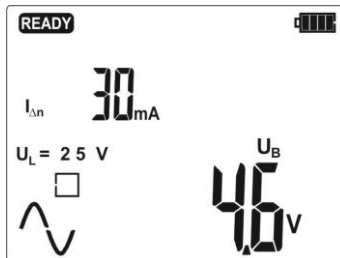

Touch voltage U_B

9



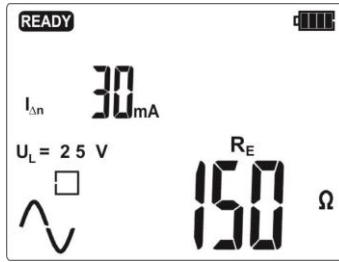

Protective conductor resistance for RCD - R_E

Notes:

- If only the measurement of U_B , R_E is selected, these values are measured with the $0,4I_{\Delta n}$ current without tripping the RCD. If the RCD trips during the measurement, press **ESC** to go to the next measurements.
- Due to the specific character of the measurement (step increase of the $I_{\Delta n}$ current), the measurement result for the tripping time $t_{\Delta I}$ in this mode may include a positive error or the **rCD** message may be displayed due to the RCD inertia. If the result is outside the allowed range for a given RCD, repeat the measurement in the t_A mode (see section 2.7.2).
- Save the result in the memory (see section 3.2) or press the **ESC** button to display the voltage only. The last measurement result is remembered until you press the **START** button or change the dial switch position.

Additional information displayed by the meter

READY	Meter ready for measurement
L-PE	Voltage on the meter L and N terminals is out of range for which the measurement can be made.
↔	The L and N conductors are switched (voltage between the PE and N conductors).
!	Temperature inside the meter has exceeded the allowed limit. The measurement is blocked.
rCD	RCD did not trip or tripped during the U_B , R_E measurement.
rE	R_E measurement range is exceeded
ErrE	After the U_B R_E measurement, the t_A measurement was not performed because the R_E and voltage values did not allow generating the required current value.
U_b	Safe touch voltage is exceeded.

2.9.2 Measurement of the RCD tripping time

1

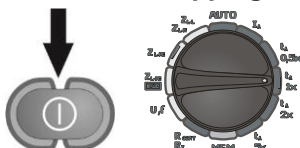

Switch on the meter. Set the dial switch to the t_A position with the selected $I_{\Delta n}$ multiplication factor.

- 2 Set the parameters according to the following algorithm and the rules for setting the general parameters.

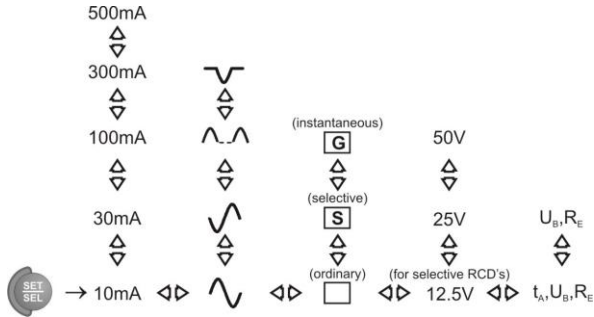

Parameter	$I_{\Delta n}$	Current waveform	RCD type	U_L	Measurement mode
-----------	----------------	------------------	----------	-------	------------------

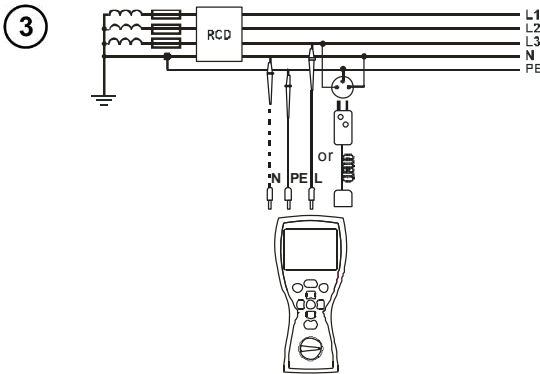

Connect the test leads as shown in the figure.

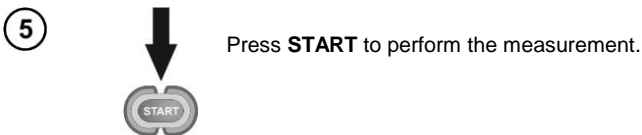
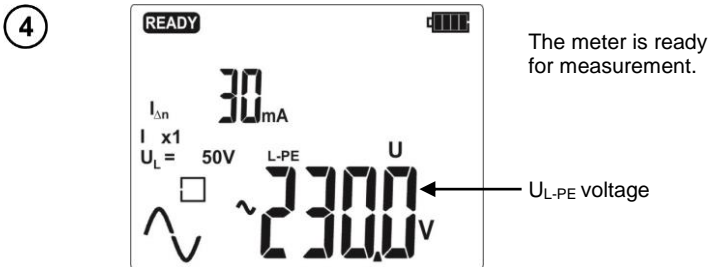

6

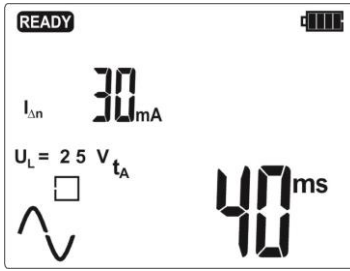

Read the main measurement result: tripping time t_A .

7



Press  to read additional results.

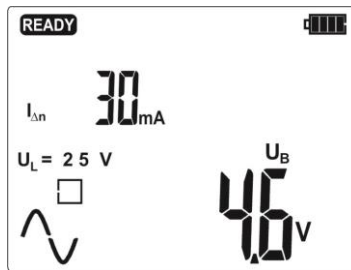

Touch voltage U_B

8

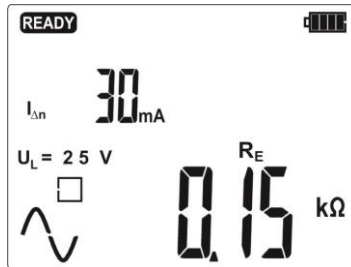

Protective conductor resistance for RCD - R_E

Notes and information displayed by the meter as in section 2.8.1.

2.9.3 Automatic RCD parameters measurement

The instrument can perform automatic measurement of the RCD tripping time t_A , tripping current $I_{\Delta n}$, touch voltage U_B and earth resistance R_E . In this mode, you do not need to activate the measurement each time, and your role is only to initiate the measurement and reset the RCD after each tripping.

In the MPI-502 main menu, you can choose two main AUTO modes:

- FULL mode
- STANDARD mode

Mode selection is described in section 2.2.

5



Press **START** to perform the measurement.

6

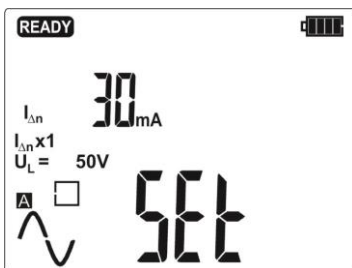

Reset the tested RCD after each tripping.

7

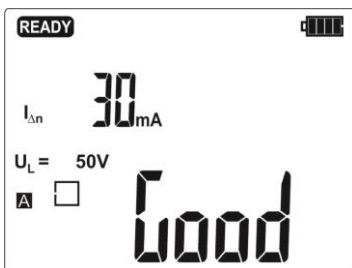

Read the main measurement result: **Good** - or **bad**.

Use the **ENTER** button to save the results in the memory, the \leftarrow and \rightarrow arrows to view the result components. or the **ESC** button to go to the voltage display mode.
The meter can perform the following measurements:

For RCD AC:

Item	Measured parameters	Measurement conditions	
		Multiplication factor $I_{\Delta n}$	Initial phase (polarization)
1.	Z_{L-PE}		
2.	$U_{B, RE}$		
3.	$t_A \searrow$	$0.5I_{\Delta n}$	positive
4.	$t_A \nearrow$	$0.5I_{\Delta n}$	negative
5.*	$t_A \searrow$	$1I_{\Delta n}$	positive
6.*	$t_A \nearrow$	$1I_{\Delta n}$	negative
7.*	$t_A \searrow$	$2I_{\Delta n}$	positive
8.*	$t_A \nearrow$	$2I_{\Delta n}$	negative
9.*	$t_A \searrow$	$5I_{\Delta n}$	positive
10.*	$t_A \nearrow$	$5I_{\Delta n}$	negative
11.*	$I_A \searrow$		positive
12.*	$I_A \nearrow$		negative

* points at which an RCD in good working order should trip

For RCD A:

Item	Measured parameters	Measurement conditions	
		Multiplication factor $I_{\Delta n}$	Initial phase (polarization)
1.	Z_{L-PE}		
2.	U_B, R_E		
3.	$t_A \searrow$	$0,5I_{\Delta n}$	positive
4.	$t_A \nearrow$	$0,5I_{\Delta n}$	negative
5.*	$t_A \searrow$	$1I_{\Delta n}$	positive
6.*	$t_A \nearrow$	$1I_{\Delta n}$	negative
7.*	$t_A \searrow$	$2I_{\Delta n}$	positive
8.*	$t_A \nearrow$	$2I_{\Delta n}$	negative
9.*	$t_A \searrow$	$5I_{\Delta n}$	positive
10.*	$t_A \nearrow$	$5I_{\Delta n}$	negative
11.*	$I_A \searrow$		positive
12.*	$I_A \nearrow$		negative
13.*	$t_A \wedge \wedge$	$0,5I_{\Delta n}$	positive
14.*	$t_A \vee \vee$	$0,5I_{\Delta n}$	negative
15.*	$t_A \wedge \wedge$	$1I_{\Delta n}$	positive
16.*	$t_A \vee \vee$	$1I_{\Delta n}$	negative
17.*	$t_A \wedge \wedge$	$2I_{\Delta n}$	positive
18.*	$t_A \vee \vee$	$2I_{\Delta n}$	negative
19.*	$t_A \wedge \wedge$	$5I_{\Delta n}$	positive
20.*	$t_A \vee \vee$	$5I_{\Delta n}$	negative
21.*	$I_A \wedge \wedge$		positive
22.*	$I_A \vee \vee$		negative

* points at which an RCD in good working order should trip

Notes:

- Number of measured parameters depends on settings in the main menu.
- U_B and R_E are measured always.
- If during the U_B/R_E measurement, the RCD has tripped at 50% $I_{\Delta n}$, or has not tripped in the remaining cases, or the preset safe voltage value U_L has been exceeded, the measurement is discontinued.
- The meter automatically skips the measurements which are not possible, for example when the selected current $I_{\Delta n}$ and multiplication factor are beyond the meter's measuring range.

Additional information displayed by the meter

Good	RCD in good working order.
bRd	Defective RCD.
SEt	Reset RCD.

The remaining information displayed by the meter as in section 2.8.1.

2.9.3.2 STANDARD mode

1

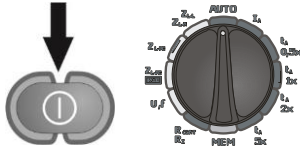

Switch on the meter.
Set the dial switch to the **AUTO** position.

2

If the displayed parameters are different than shown below, set them according to the following algorithm and the rules for setting the general parameters.

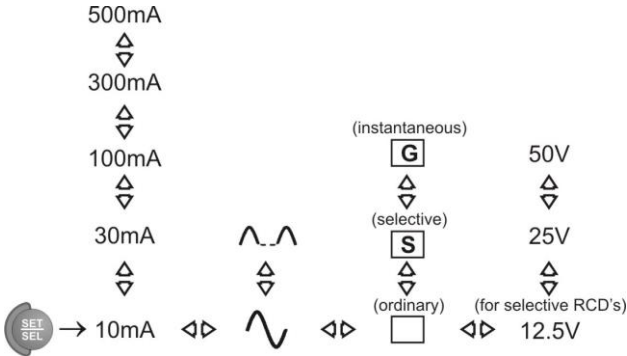

Parameter	$I_{\Delta n}$	Current waveform	RCD type	U_L
-----------	----------------	------------------	----------	-------

3

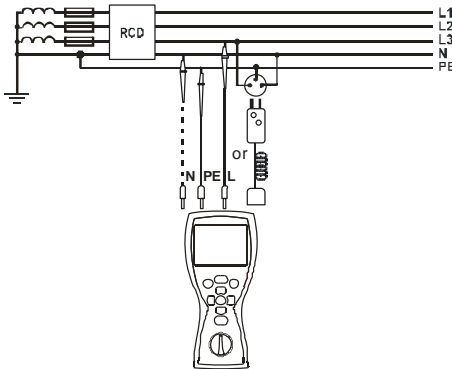

Connect the test leads as shown in the figure.

4

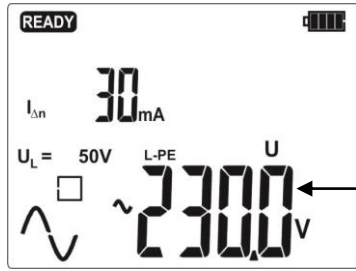

The meter is ready for measurement.

U_{L-PE} voltage

5



Press **START** to perform the measurement.



6

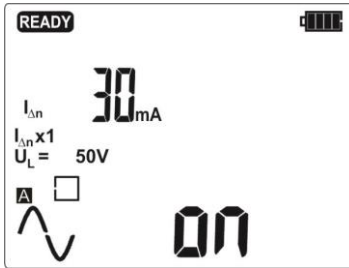

Reset the tested RCD after each tripping.

7

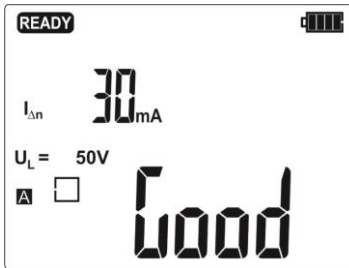

Read the main measurement result: **Good** or **bAd**.

Notes:

- Measured parameters are the same as in the table for the FULL and RCD AC mode only for selected current waveform.
- The remaining notes and information as in section 2.8.3.1.

4

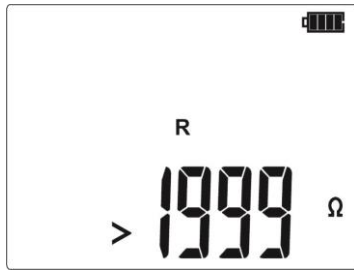

The meter is ready for measurement.

5

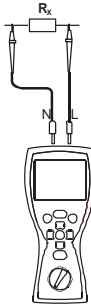

Connect the test leads as shown in the figure.

6

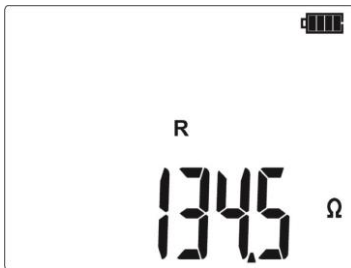

Read the measurement result.

Additional information displayed by the meter

LDL	Tested facility is live. The measurement is blocked. Immediately disconnect the meter from the facility (both leads).
NOISE!	Message (displayed after the measurement) indicates significant disturbances in the mains during measurement. The measurement result may include a large, unspecified error.
> 400 °	Measurement range is exceeded.

3 Memory of measurement results

The MPI-502 meters have the memory for 10000 individual measurement results. The whole memory is divided into 10 banks with 99 cells each. Due to dynamic memory allocation, each cell can contain a different number of individual results, depending on the needs. This ensures optimum memory use. Each result can be saved in a cell of a specified number and in a chosen bank, thus allowing the user to assign the cell numbers to measurement points, and the bank numbers to tested facilities, make the measurement in any sequence and repeat the measurements without losing other data.

The memory of measurement results is **not cleared** when the meter is switched off. The data can be read later or transmitted to a computer. The number of the current cell and bank is not changed, either.

Notes:

- One cell can contain the results of measurements made for all measurement functions.
- After each entry of measurement result to a cell, the cell number is automatically increased. To enter the successive results relating to a given measurement point (facility) to one cell, set the correct cell number before each entry.
- Only the results of measurements activated with the **START** button can be entered to the memory (with exception of auto-zeroing in the low-voltage resistance measurement).
- It is recommended to clear the memory after reading the data or before a new series of measurements, results of which can be saved in the same cells as previous ones.

3.1 Entering the measurement results to the memory

①



After the measurement, press **ENTER**.
The meter is in the memory enter mode.

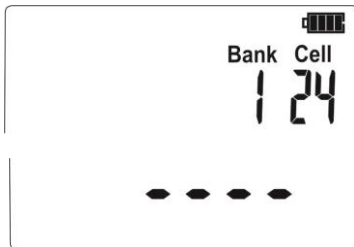

Cell is empty.



Cell includes the same type of result that is to be entered.



Cell includes the displayed types of measurement results.

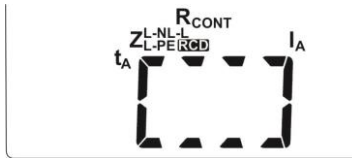

Cell includes all types of measurement results.

2

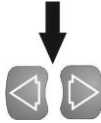

Use the ◀ and ▶ arrows to view the result types and components.

3



After choosing the bank and cell number (section 3.2) or leaving the current one, again press **ENTER**. The screen shown below appears for a moment accompanied by three short audio signals. Then, the meter again displays the last measurement result.

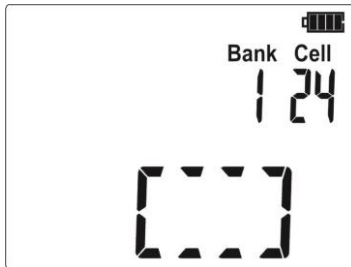

4

An attempt to overwrite the results triggers the warning message.



5

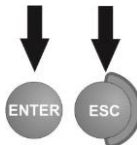

Press **ENTER** to overwrite the result or **ESC** to abort.

Notes:

- In case of RCD's, this warning will be displayed also when an attempt is made to enter a given result type (component) of the measurement made at a different set $I_{\Delta n}$ current or for a different set RCD type (ordinary/ selective) than the results saved in this cell. Entering the results for a different $I_{\Delta n}$ current or other RCD type will cause deletion of all previously saved results for a given RCD.
- The saved data include a complete set of results (main and additional) for a given measurement function plus the set measurement parameters.

3.2 Changing the cell and bank number

①



After the measurement, press **ENTER**.
The meter is in the memory enter mode.

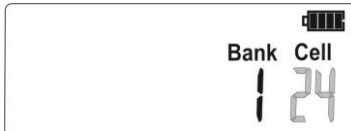

The cell number is flashing.

②



Use the **SET/SEL** button to set the active (flashing) cell or bank number.



Use the Δ and ∇ arrows to change the cell or bank number.

3.3 Browsing the memory

①

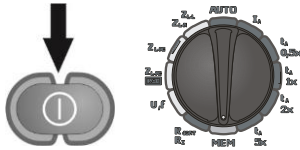

Switch on the meter.
Set the dial switch to the **MEM** position.















The content of last saved cell is displayed.

The cell number is flashing.

The bank and cell number which you wish to browse is changed with the **SET/SEL** button and then with the Δ and ∇ arrows.
If the cell/ bank number is flashing, it can be changed.

The sequence of saving the individual measurement results is given in the table below:

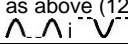
Item	Measurement function (result group)	Component results
1	$Z_{L-N, L-L}$	Z_{L-N} or Z_{L-L} and U_{L-N} or U_{L-L}
		I_K
		R
		X_L
2	Z_{L-PE} lub Z_{L-PE} RCD	Z_{L-PE} and U_{L-PE}
		I_K
		R
		X_L
3	R_{CONT}	R
RCD		U_B
		R_E
		t_A at $0,5I_{\Delta n}$, 
		t_A at $0,5I_{\Delta n}$, 
		t_A at $1I_{\Delta n}$, 
		t_A at $1I_{\Delta n}$, 
		t_A at $2I_{\Delta n}$, 
		t_A at $2I_{\Delta n}$, 
		t_A at $5I_{\Delta n}$, 
		t_A at $5I_{\Delta n}$, 
		I_A , 
		I_A , 
		t_{AI} ,  (absence for RCD AUTO)
		t_{AI} ,  (absence for RCD AUTO)
		as above (12 rows) for pulsating current 

3.4 Clearing the memory

3.4.1 Clearing the bank

①

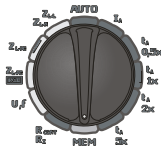

Switch on the meter.
Set the dial switch to the **MEM** position.

②





Set the number of bank to be cleared as described in 3.2.
Set the cell number to -- (before 1). The **del** message appears, signaling that the meter is ready to delete.

③

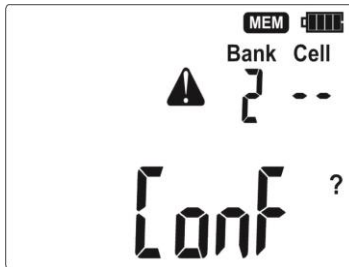

Press **ENTER**.



The **Conf** and  symbols appear, requiring confirmation.

④



Press **ENTER** to start deleting or **ESC** to abort.

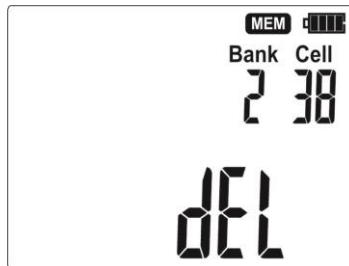

The deletion progress is shown on the screen as scrolling cell numbers. When deletion is completed, the meter generates three short audio signals and sets the cell number to 1.

3.5 Communication with computer

3.5.1 Package for cooperation with computer

In order to ensure the communication of the meter with a computer, Bluetooth/OR-1 module is required with an additional software. A program that may be used for this purpose is **Sonel Reader**. It allows users to read and display the measurement data stored in the meter memory. This program may be downloaded free from the manufacturer's website: www.sonel.pl. It is also provided on DVD, supplied with the meter. Information on the availability of other programs cooperating with the meter may be obtained from the manufacturer or its authorized distributors.

The software may be used for many devices manufactured by SONEL S.A. which are equipped with the USB interface and/or wireless module.

Detailed information regarding software is available from the manufacturer or an authorised distributor.

3.5.2 Data transmission with Bluetooth 4.2 module

The feature is available in meters with serial number prefix **EE**.

- 1

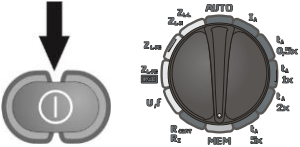

Switch on the meter. Set the dial switch to the **MEM** position.
- 2

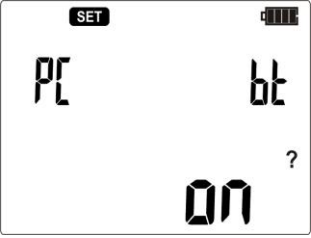

Press the **SET/SEL** button (for about 2 sec). The following screen appears, inquiring about initiation of wireless communication.

- 3



Press **ENTER**. The wireless communication screen will appear.

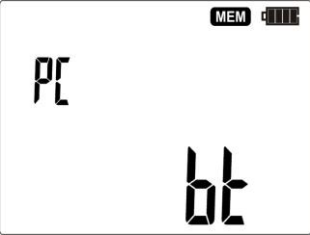



- ④ Connect Bluetooth module to the USB socket of the PC, unless it is integrated into the PC.
- ⑤ During the process of pairing the meter with a PC enter PIN code compatible with the PIN code of the meter defined in main settings.
- ⑥ On the computer start data storing programme. To transmit the data, follow the instruction from your software.



Press **ESC** to exit the communication mode.

⚠
Standard pin for Bluetooth is the „0123”. Settings in the meter according to section 2.2.

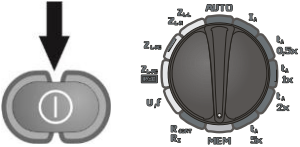
3.5.3 Data transmission

The feature is available in meters with serial number prefix **AE**.

- ① Connect the OR-1 to the USB port of the PC.
- ②  Switch on the meter. Set the dial switch to the **MEM** position.
- ③  Press the **SET/SEL** button (for about 2 sec). The following screen appears, inquiring about initiation of radio transmission.

- ④  Press **ENTER**. The radio transmission screen will appear.

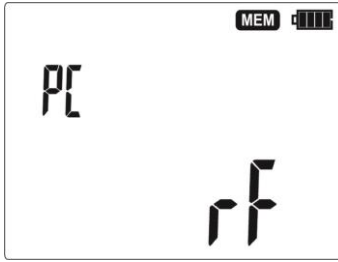

To transmit the data, follow the instruction from your software. Press **ESC** to exit the communication mode.

Note:



Standard pin for OR-1 is the „123”. Settings in the meter according to section 2.2.

4 Troubleshooting

Before sending the instrument for repairs, call our service. Perhaps the meter is not damaged, and the problem has been caused by some other reasons.

The meter can be repaired only at outlets authorized by the manufacturer.

Troubleshooting of typical problems during the use of the meter is described in the table below.

Measurement function	Symptom	Cause	Action
All	The meter will not switch off with the  button. The  symbol appears during voltage measurement. The meter switches off during preliminary test.	Discharged or incorrectly placed batteries.	Check if the batteries are placed correctly; replace or charge the batteries. If this has not helped, send the meter for repair.
	Measurement errors after the meter has been transferred from cold environment to warm and humid one.	No acclimatization	Do not make measurement until the meter reaches the ambient temperature (about 30 minutes) and dries.
Fault loop and RCD	Successive results in the same measurement point are significantly different	Incorrect connections in the tested installation	Check and remove the defects
		Mains with a lot of disturbance or unstable voltage	Make more measurements, average the results

Measurement function	Symptom	Cause	Action
Fault loop	The meter indicates the values close to zero or zero irrespective of the measurement location, and displayed values are significantly different than expected	Incorrectly chosen test leads in the meter settings	
RCD	During the touch voltage or earth resistance measurement, the RCD trips (RCD trips at only 40% of the $I_{\Delta n}$ set).	$I_{\Delta n}$ set too high	Set correct $I_{\Delta n}$
		Relatively high leakage currents in the installation	Reduce the leakage currents
		Defects in the installation	Verify the correctness of N and PE connections
	The RCD does not trip during the tripping test	$I_{\Delta n}$ set too low	Set correct $I_{\Delta n}$
		Incorrectly set current waveform	Set correct current waveform
		Damaged RCD	test the RCD with the TEST button; replace if necessary
		Defects in the installation	Verify the correctness of N and PE connections
	During the tripping current measurement, the r_{cd} symbol is displayed even if the RCD has tripped.	The RCD tripping time is longer than the measurement time.	RCD should be considered defective.
	Large differences between repeated measurements of the RCD tripping time	Pre-magnetization of the transformer core inside the RCD	Normal for some direct action residual current devices; try to make next measurements at reversed polarity of the residual current.
	Measurement of t_A or I_A is impossible	Touch voltage generated during the t_A or I_A measurement may exceed the safe voltage level – the measurement is automatically blocked	Check connections in the protective conductor Verify correct RCD selection in terms of rated residual current
		$I_{\Delta n}$ set too high	Set correct $I_{\Delta n}$
	Unstable U_B or R_E measurement results, i.e. successive results in the same measurement point are significantly different	Significant leakage currents, highly variable	
The PE symbol is not displayed even if the voltage between the contact electrode and the PE conductor exceeds the detector tripping threshold (about 50V)	Contact electrode does not function well or the meter's input circuits are damaged	Sent the meter for repair; use of defective meter is not permitted	
	Dial switch is not set correctly	Contact electrode is active for the measurements of earth loop parameters and RCD, with the exception of the $Z_{L-N,L-L}$ $U_{L-N,L-L}$ function	

5 Power supply

5.1 Monitoring the power supply voltage

The batteries charging level is indicated by the symbol located in the top right-hand corner of the screen:

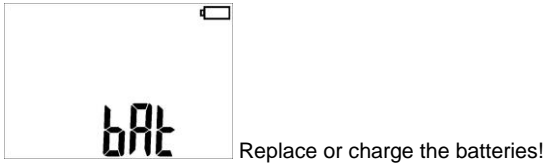
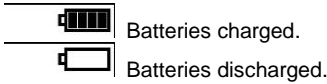

Remember that:

- the **bat** message on the display indicates insufficient power supply voltage and the need to replace or charge the batteries,
- the measurements made with the meter with insufficient power supply voltage have additional measurement error which is impossible to be estimated by the user.

5.2 Replacing the batteries

The power supply of the MPI-502 meter is from four LR6 alkaline batteries or four NiMH rechargeable batteries (size AA). The batteries are in a compartment in the bottom part of the casing.

WARNING:
Before replacing the batteries, disconnect the test leads from the meter.

To replace the batteries:

1. Disconnect the leads from the measurement circuit and switch off the meter.
2. Unscrew the bolt fastening the battery compartment cover (in the bottom part of the casing).
3. Replace all batteries. Observe correct polarity when putting new batteries ("+" at the spring part of the contact plate). Reversed polarity of the batteries will not damage the meter or the batteries, but the meter will not work.
4. Put the cover in place and fasten it with the bolt.

NOTE!
After replacement of batteries, set the power supply type in the main menu because correct charging level indication depends on this. Discharging characteristics of batteries and rechargeable batteries are different.

NOTE!
If batteries leak in the compartment, send the meter to the service outlet.

Rechargeable batteries should be charged in an external charger.

5.3 General rules of using the Nickel Metal Hydride (Ni-MH) batteries

- If you are not going to use the instrument for a longer time, remove the rechargeable batteries and store them separately.
- Store the rechargeable batteries in a dry, cool and well ventilated place and protect them from direct sunlight. The long storage temperature should be below 30 degrees C. If the batteries are stored long at high temperatures, the chemical processes may reduce their life.
- The NiMH rechargeable batteries usually withstand 500-1000 charging cycles. Such batteries achieve full capacity after forming (2-3 discharging and charging cycles). The most important factor which influences the battery life is the discharge level. The deeper the discharge level, the shorter the battery life.
- The memory effect appears in the NiMH batteries in a limited scope. These batteries can be recharged without more serious consequences. It is, however, recommended to discharge them completely every few cycles.
- During the storage of the Ni-MH rechargeable batteries, they are subject to self-discharge process at the rate of about 30% a month. Keeping the batteries at high temperatures may accelerate this process even two times. In order not to allow an excessive discharging of the batteries (after which the forming will be needed), recharge the batteries once in a while (even unused batteries).
- Modern, fast chargers detect too low and too high temperature of the batteries and respond accordingly. If the temperature is too low, the charging process should not start as it might irrevocably damage a rechargeable battery. The battery temperature increase is a signal to stop the charging and is typical. In addition to faster temperature increase of a battery which will not be fully charged, charging at high ambient temperatures results, however, in a reduced life.
- Remember that with fast charging, the batteries are charged to about 80% of their capacity; better results can be achieved by continuing the charging process: the charger then goes into the small current charging mode and after a few hours the batteries are fully charged.
- Do not charge and do not use the batteries at extreme temperatures as they reduce the life of batteries. Avoid using the battery-powered devices in very hot places. The rated operating temperature must be observed at all times.

6 Cleaning and maintenance

NOTE!

Use only the maintenance methods presented by the manufacturer in this manual.

Clean the meter casing and the case with a wet cloth, using generally available detergents. Do not use any solvents and cleaning media which could scratch the casing (powder, paste, etc.).

The probes can be cleaned with water and then wiped dry. Before longer storage, it is recommended to lubricate the probes with any machine grease.

Clean the spools and leads with water and detergents, then wipe dry.

The meter electronic system is maintenance free.

7 Storage

When storing the instrument, observe the following recommendations:

- disconnect all leads from the meter,
- thoroughly clean the meter and all accessories,
- wind long test leads onto the spools,
- if you are not going to use the instrument for a longer time, remove the batteries,
- during a prolonged storage recharge the batteries from time to time to prevent total discharging.

8 Dismantling and disposal

Used electric and electronic equipment should be collected selectively, i.e. not placed with other types of waste.

Used electronic equipment shall be sent to the collection point according to the Used Electric and Electronic Equipment Act.

Before sending the instrument to the collection point, do not dismantle any parts by yourself.

Observe local regulations on disposal of packagings and used batteries.

9 Technical specification

9.1 Basic information

⇒ “m.v.” abbreviation in determination of basic uncertainty means a standard measured value.

Voltage measurement

Range	Resolution	Basic uncertainty
0.0...299.9V	0.1V	±(2% m.v. + 6 digits)
300...500V	1V	±(2% m.v. + 2 digits)

- Frequency range: 45...65Hz

Frequency measurement

Range	Resolution	Basic uncertainty
45.0...65.0Hz	0.1Hz	±(0,1% m.v. + 1 digit)

- Voltage distribution: 50...500V

Z_{L-PE}, Z_{L-N}, Z_{L-L} fault loop impedance measurement

Z_s fault loop impedance measurement

Measurement range according to IEC 61557:

Test lead	Measurement range Z _s
1,2m	0,13...1999 Ω
5m	0,17...1999 Ω
10m	0,21...1999 Ω
20m	0,29...1999 Ω
WS-01, -05	0,19...1999 Ω

Display ranges:

Display range	Resolution	Basic uncertainty
0...19.99 Ω	0.01 Ω	$\pm(5\% \text{ m.v.} + 3 \text{ digits})$
20.0...199.9 Ω	0.1 Ω	$\pm(5\% \text{ m.v.} + 3 \text{ digits})$
200...1999 Ω	1 Ω	$\pm(5\% \text{ m.v.} + 3 \text{ digits})$

- Rated operating voltage U_{nL-N}/ U_{nL-L} : 220/380V, 230/400V, 240/415V
- Voltage operating range: 180...270V (dla Z_{L-PE} i Z_{L-N}) and 180...460V (for Z_{L-L})
- Mains rated frequency f_n : 50Hz, 60Hz
- Frequency operating range: 45...65Hz
- Maximum test current: 7.6A dla 230V (3x10ms), 13.3A for 400V (3x10ms)
- Check of PE terminal connection correctness with the contact electrode (for Z_{L-PE})

Readings of fault loop impedance R_S and fault loop reactance X_S

Display range	Resolution	Basic uncertainty
0...19.99 Ω	0.01 Ω	$\pm(5\% + 5 \text{ digits})$ of Z_S value
20.0...199.9 Ω	0.1 Ω	$\pm(5\% + 5 \text{ digits})$ of Z_S value

- Calculated and displayed values $Z_S < 200\Omega$

Readings of short-circuit current I_k

Measurement ranges according to IEC 61557 can be calculated from the measurement ranges Z_S and rated voltages.

Display range	Resolution	Basic uncertainty
0.110...1.999A	0.001 A	Calculated on the basis of uncertainty for the fault loop
2.00...19.99A	0.01 A	
20.0...199.9A	0.1 A	
200...1999A	1 A	
2.00...19.99kA	0.01 kA	
20.0...40.0kA	0.1 kA	

- Prospective fault current calculated and displayed by the meter may slightly differ from the value calculated by the user with a calculator, basing on the displayed value of the impedance, because the meter calculates the current from unrounded value of fault loop impedance (which is used for displaying). As the correct value, consider I_k current value, displayed by the meter or by firmware.

Z_{L-PE} fault loop impedance measurement \overline{RCD} (without tripping the RCD)

Z_S fault loop impedance measurement

Measurement range according to IEC 61557: 0.5...1999 Ω for the 1.2m, WS01 and WS05 leads, and 0.51...1999 Ω for the 5m, 10m and 20m leads

Display range	Resolution	Basic uncertainty
0...19.99 Ω	0.01 Ω	$\pm(6\% \text{ m.v.} + 10 \text{ digits})$
20.0...199.9 Ω	0.1 Ω	$\pm(6\% \text{ m.v.} + 5 \text{ digits})$
200...1999 Ω	1 Ω	$\pm(6\% \text{ m.v.} + 5 \text{ digits})$

- Does not trip the RCD's with $I_{\Delta n} \geq 30\text{mA}$
- Rated operating voltage U_n : 220V, 230V, 240V
- Voltage operating range: 180...270V
- Mains rated frequency f_n : 50Hz, 60Hz
- Frequency operating range: 45...65Hz
- Check of PE terminal connection correctness with the contact electrode

Readings of fault loop impedance R_s and fault loop reactance X_s

Display range	Resolution	Basic uncertainty
0..19.99 Ω	0.01 Ω	$\pm(6\% + 10 \text{ digits})$ of Z_S value
20.0..199.9 Ω	0.1 Ω	$\pm(6\% + 5 \text{ digits})$ of Z_S value

- Calculated and displayed values $Z_S < 200\Omega$

Readings of short-circuit current I_k

Measurement ranges according to IEC 61557 can be calculated from the measurement ranges Z_S and rated voltages.

Display range	Resolution	Basic uncertainty
0.110...1.999A	0.001 A	Calculated on the basis of uncertainty for the fault loop
2.00...19.99A	0.01 A	
20.0...199.9A	0.1 A	
200...1999A	1 A	
2.00...19.99kA	0.01 kA	
20.0...24.0kA	0.1 kA	

- Prospective fault current calculated and displayed by the meter may slightly differ from the value calculated by the user with a calculator, basing on the displayed value of the impedance, because the meter calculates the current from unrounded value of fault loop impedance (which is used for displaying). As the correct value, consider I_k current value, displayed by the meter or by firmware.

Measurement of the RCD parameters

- Rated operating voltage U_n : 220V, 230V, 240V
- Voltage operating range: 180...270V
- Mains rated frequency f_n : 50Hz, 60Hz
- Frequency operating range: 45...65Hz

RCD tripping test and t_A tripping time measurement (for t_A measurement function)

Measurement range according to IEC 61557: 10ms ... to the upper limit of displayed value









RCD type	Multiplication factor setting	Measurement range	Resolution	Basic uncertainty
general	0,5 $I_{\Delta n}$	0..300ms	1 ms	$\pm 2\% \text{ m.v. } \pm 2 \text{ cyfry}^{1)}$
	1 $I_{\Delta n}$			
	2 $I_{\Delta n}$	0..150ms		
	5 $I_{\Delta n}$	0..40ms		
selective	0,5 $I_{\Delta n}$	0..500ms		
	1 $I_{\Delta n}$			
	2 $I_{\Delta n}$	0..200ms		
	5 $I_{\Delta n}$	0..150ms		

1) for $I_{\Delta n} = 10\text{mA}$ and 0,5 $I_{\Delta n}$ the uncertainty is $\pm 2\% \text{ m.w. } \pm 3 \text{ digits}$

- Residual current feed accuracy:

for 1* $I_{\Delta n}$, 2* $I_{\Delta n}$ and 5* $I_{\Delta n}$ 0..8%
 for 0,5* $I_{\Delta n}$ -8..0%

RMS leakage current during the RCD tripping time measurement

$I_{\Delta n}$	Multiplication factor setting							
	0,5		1		2		5	
								
10	5	3,5	10	20	20	40	50	100
30	15	10,5	30	42	60	84	150	210
100	50	35	100	140	200	280	500	—
300	150	105	300	420	—	—	—	—
500	250	175	500	—	—	—	—	—

R_E - protective conductor resistance for RCD

Selected RCD rated current	Measurement range	Resolution	Test current	Basic uncertainty
10 mA	0.01k Ω ..5.00 k Ω	0,01 k Ω	4 mA	0...+10% m.v. \pm 8 digits
30 mA	0,01k Ω ..1.66k Ω		12 mA	0...+10% m.v. \pm 5 digits
100 mA	1 Ω ..500 Ω	1 Ω	40 mA	0...+5% m.v. \pm 5 digits
300 mA	1 Ω ..166 Ω		120 mA	
500 mA	1 Ω ..100 Ω		200 mA	

Measurement of touch voltage U_B referred to rated residual current

Measurement range according to IEC 61557: 10...50V

Measurement range	Resolution	Test current	Basic uncertainty
0..9,9V	0.1 V	0.4 x $I_{\Delta n}$	0..10% m.v. \pm 5 digits
10.0..99.9V			0..15% m.v.

RCD I_A tripping current measurement for sinusoidal residual current

Measurement range according to IEC 61557: (0.3...1,0) $I_{\Delta n}$

Selected RCD rated current	Measurement range	Resolution	Test current	Basic uncertainty
10 mA	3.0..10.0mA	0,1 mA	0,3 x $I_{\Delta n}$..1,0 x $I_{\Delta n}$	\pm 5 % $I_{\Delta n}$
30 mA	9,0..30,0 mA	1 mA		
100 mA	30..100 mA			
300 mA	90..300 mA			
500 mA	150..500 mA			

- It is possible to start the measurement from positive or negative half-period of forced residual current
- Test current flow time max. 3200 ms

RCD I_A tripping current measurement for unidirectional pulsating residual current

Measurement range according to IEC 61557: (0.4...1,4) $I_{\Delta n}$ for $I_{\Delta n} \geq 30$ mA and (0,4...2) $I_{\Delta n}$ for $I_{\Delta n} = 10$ mA

Selected RCD rated current	Measurement range	Resolution	Test current	Basic uncertainty
10mA	4.0..20.0mA	0.1mA	0,35 x $I_{\Delta n}$..2,0 x $I_{\Delta n}$	\pm 10 % $I_{\Delta n}$
30mA	12.0..42.0mA			
100mA	40..140mA	1mA	0,35 x $I_{\Delta n}$..1,4 x $I_{\Delta n}$	\pm 10 % $I_{\Delta n}$
300mA	120..420mA			

- It is possible to start the measurement from positive or negative half-period of forced residual current
- Test current flow time max. 3200 ms

Low-voltage continuity and resistance measurement

Continuity measurements of protective conductors and equipotential bonding with the $\pm 200\text{mA}$ current

Measurement range according to IEC 61557-4: 0,12...400 Ω

Range	Resolution	Basic uncertainty
0,00...19,99 Ω	0,01 Ω	$\pm(2\% \text{ m.v.} + 3 \text{ digits})$
20,0...199,9 Ω	0,1 Ω	
200...400 Ω	1 Ω	

- Voltage on open terminals: 4...9V
- Output current at $R < 2\Omega$: min 200mA (I_{SC} : 200...250mA)
- Test leads resistance compensation
- Measurements for both current polarities

Low-current resistance measurement

Range	Resolution	Basic uncertainty
0.0...199.9 Ω	0.1 Ω	$\pm(3\% \text{ m.v.} + 3 \text{ digits})$
200...1999 Ω	1 Ω	

- Voltage on open terminals: 4...9V
- Short-circuit current I_{SC} : <8mA
- Audio signal for measured resistance < 30 $\Omega \pm 50\%$
- Test leads resistance compensation

Other technical specifications

- Insulation type double, according to EN 61010-1 and IEC 61557
- Measurement category IV 300V (III 600V) according to EN 61010-1
- casing protection rating according to EN 60529 IP67
- meter power supply LR6 alkaline batteries or AA size NiMH rechargeable batteries (4pcs)
- dimensions 220x98x58 mm
- meter weight about 0.6 kg
- storage temperature -20...+70°C
- operating temperature 0...+50°C
- humidity 20...90%
- reference temperature +23 \pm 2°C
- reference humidity 40...60%
- altitude (above sea level) <2000 m
- time to Auto-OFF 300, 600, 900 seconds or none
- number of Z or RCD measurements (for rechargeable batteries) >5000 (2 measurements per minute)
- display LCD segment
- measurement results memory 990 cells, 10000 entries
- transmission of results radio interface, waveband ISM 433 MHz
- quality standard development, design and manufacture according to ISO 9001, ISO 14001, PN-N-18001
- instrument conforming to IEC 61557
- product meets the EMC requirements (resistance for industrial environments) according to the standards EN 61326-1 and EN 61326-2-2

9.2 Additional information

Information about additional uncertainty is useful mainly when the meter is used in untypical conditions and for the measurements laboratories during calibration.

9.2.1 Additional uncertainty according to IEC 61557-3 (Z)

Influencing value	Designation	Additional uncertainty
Location	E ₁	0%
Supply voltage	E ₂	0% (BAT is not displayed)
Temperature 0...35°C	E ₃	1.2m lead – 0Ω 5m lead – 0.011Ω 10m lead – 0.019Ω 20m lead – 0.035Ω WS-01, WS-05 leads – 0.015Ω
Phase angle 0..30° at the bottom of measurement range	E _{6,2}	0.6%
Frequency 99%..101%	E ₇	0%
Mains voltage 85%..110%	E ₈	0%
Harmonics	E ₉	0%
DC component	E ₁₀	0%

9.2.2 Additional uncertainty according to IEC 61557-4 (R ±200mA)

Influencing value	Designation	Additional uncertainty
Location	E ₁	0%
Supply voltage	E ₂	0,5% (BAT is not displayed)
Temperature 0...35°C	E ₃	1,5%

9.2.3 Additional uncertainty according to IEC 61557-6 (RCD)

I_A, t_A, U_B

Influencing value	Designation	Additional uncertainty
Location	E ₁	0%
Supply voltage	E ₂	0% (BAT is not displayed)
Temperature 0...35°C	E ₃	0%
Electrodes resistance	E ₅	0%
Mains voltage 85%..110%	E ₈	0%

10 Accessories

The current list of accessories can be found on the manufacturer's website.

10.1 Standard accessories

The standard kit delivered by the manufacturer includes:

- MPI-502 meter
- Test leads kit:
 - WS-05 adapter with UNI-SCHUKO (CAT III 300V) plug and the buttons for measurement activation and saving the measurement result in the memory – **WAADAWS05**
 - 1.2m leads (CAT III 1000V) with banana plugs – 3 pcs (yellow – **WAPRZ1X2YEBB**, red – **WAPRZ1X2REBB** and blue - **WAPRZ1X2BUBB**)
- accessories
 - crocodile clip (CAT III 1000V) – 1 pc (yellow K02 – **WAKROYE20K02**)
 - blade probe with banana socket (CAT III 1000V) – 2 pcs (red – **WASONREOGB1** and blue – **WASONBUOGB1**)
- case for meter and accessories – **WAFUTM6**
- meter harness – **WAPOZSZE4**
- rigid hanger with hook – **WAPOZUCH1**
- user manual,
- calibration certificate
- 4 LR6 batteries

10.2 Optional accessories

In addition, the following items not included in the standard kit can be purchased from the manufacturer or the distributors:

WAPRZ005REBB
WAPRZ010REBB
WAPRZ020REBB



- 5 / 10 / 20 m lead, red

WAKROYE20K02



- crocodile clip, red

WASONYEGB1



- pin probe with banana socket

WAADAWS01



- WS-01 measurement activation adapter with the UNI-Schuko plug

WAADAAGT16P - five-wire version
WAADAAGT16C - four-wire version



- AGT-16P adapter for three-phase sockets

WAADAAGT63P - five-wire version



- AGT-63P adapter for three-phase sockets

WAADAAGT32P - five-wire version
WAADAAGT32C - four-wire version



- AGT-32P adapter for three-phase sockets

- Calibration Certificate issued by an accredited laboratory

11 Manufacturer

The manufacturer of the equipment and provider of service during and past the warranty period:

SONEL S.A.

Wokulskiego 11
58-100 Świdnica
Poland

tel. +48 74 858 38 60

fax +48 74 858 38 09

E-mail: export@sonel.pl

Web page: www.sonel.pl

Note:

Service repairs must be performed solely by the manufacturer.

12 Laboratory services

SONEL Testing and Calibration Laboratory has been accredited by the Polish Center for Accreditation (PCA) - certificate no. AP 173.

Laboratory offers calibration for the following instruments that are used for measuring electrical and non-electrical parameters.



AP 173

● METERS FOR MEASUREMENTS OF ELECTRICAL PARAMETERS

- voltage meters,
- current meters (including clamp meters),
- resistance meters,
- insulation resistance meters,
- earth resistance and resistivity meters,
- RCD meters,
- short-circuit loop impedance meters,
- power quality analyzers,
- portable appliance testers (PAT),
- power meters,
- multimeters,
- multifunction meters covering the functions of the above-mentioned instruments,

● ELECTRICAL STANDARDS

- calibrators,
- resistance standards,

● METERS FOR MEASUREMENTS OF NON-ELECTRICAL PARAMETERS

- pyrometers,
- thermal imagers,
- luxmeters.

The Calibration Certificate is a document that presents a relation between the calibration standard of known accuracy and meter indications with associated measurement uncertainties. The calibration standards are normally traceable to the national standard held by the National Metrological Institute.

According to ILAC-G24 „Guidelines for determination of calibration intervals of measuring instruments”, SONEL S.A. recommends periodical metrological inspection of the instruments it manufactures no less frequently than once every 12 months.

For new instruments provided with the Calibration Certificate or Validation Certificate at the factory, re-calibration should be performed within 12 months from the date of purchase, however, no later than 24 months from the date of purchase.

ATTENTION !



















The person performing the measurements should be absolutely sure about the efficiency of the device being used. Measurements made with an inefficient meter can contribute to an incorrect assessment of the effectiveness of health protection and even human life.

NOTES

WARNINGS AND GENERAL INFORMATION DISPLAY BY THE METER

NOTE!

MPI meter is designed to operate at the rated phase voltages 220V, 230V and 240V and phase-to-phase voltages 380V, 400V and 415V. Connection of the voltage higher than allowed between any of the test terminals may damage the meter and cause a hazard to the user.

	The meter is ready for measurement.
	Voltage on terminals L and N is not within measurable range.
	Voltage on terminals L and PE is not within measurable range.
	Error in the measurement.
	Error in the measurement: loss of voltage after the measurement.
	Short circuit malfunction.
	Conductor N is not connected.
	Huge noise in the system during the measurement. The measurement result may be affected by a large, unspecified error.
	The temperature inside the meter has risen above the limit. The measurement is blocked.
	The L and N conductors have been switched (voltage between terminals L and N).
	The RCD has not tripped or has tripped during the measurement of U_B , R_E .
	Safe contact voltage exceeded.
	RCD in good working order.
	RCD not in good working order.
	Switch on the RCD.
	The tested facility is live. The measurement is blocked. Immediately disconnect the meter from the facility (both conductors).
	State of the batteries: Batteries charged. Batteries discharged.
	Batteries fully discharged. Replace or recharge the batteries.



SONEL S.A.
Wokulskiego 11
58-100 Swidnica
Poland



+48 74 858 38 60
+48 74 858 38 00
fax +48 74 858 38 09

e-mail: export@sonel.pl
www.sonel.pl